

Data sheet

SonoSelect 10 and SonoSafe 10 Energy Meters

Description



The Danfoss SonoSelect 10 and SonoSafe 10 are ultrasonic compact energy meters intended for measuring energy consumption in heating, cooling and combined heating and cooling applications for billing purposes. The meters are designed for remote meter read-out (AMR).

The energy meters consist of an ultrasonic flow sensor, a pair of Pt1000 temperature sensors and a calculator with integrated circuits for temperature measurement, flow calculation and energy calculation.

Feature highlights:	
<ul style="list-style-type: none"> • Proven ultrasonic measuring principle designed for long operating life time • No calming section or inlet/outlet restrictions • Low pressure drop down to 0.03 bar at q_p • Large 85 x 35 mm LCD display with 8 digits (11.5 mm high), guiding menu and info panel • Compact design • Extensive change and error log • Memory: 4 years of data, yearly and monthly values stored (incl. pulse input) • Upgradable with communication modules in bracket (dual M-Bus, connection with water meter) • Power supply 3.6V battery (replacable) or 230V mains power • Communication baud rate 300, 2400, 4800 and 9600 bps • SonoApp usable for Android (Bluetooth LE via dongle) 	

Special features:	SonoSelect 10	SonoSafe 10
Battery	<ul style="list-style-type: none"> • 16 + 1 years battery life (from production date) 	<ul style="list-style-type: none"> • 10 + 1 years battery life
Flexibility	<ul style="list-style-type: none"> • Heating or cooling or combined heating and cooling • Supply and return can be configured on site • Energy units can be configured on site • Slot for communication upgrade • 1.5m PUR or silicone cable between calculator and flow sensor allow for flexible installation, e.g. in flat stations 	<ul style="list-style-type: none"> • Heating • Energy units can be configured on site • Slot for communication upgrade • 0.5 m cable PVC between calculator and flow sensor
Safety	<ul style="list-style-type: none"> • EN1434 class 2 + flow and energy calculated every 0.5 second • Tamper monitor sets alarm if meter is opened by unauthorized personnel • Diagnostic function to secure confidence in meter data • IP65 calculator • Reverse flow indication 	<ul style="list-style-type: none"> • EN1434 class 2 + flow and energy calculated every 2 seconds • IP54 calculator
SonoApp	<ul style="list-style-type: none"> • Installer tool (Guides and configure e.g. AMR, Pulse, units, supply/return) • Commissioning tool (Link location to serial number) • Operation tool (walk by + diagnostics) 	<ul style="list-style-type: none"> • Installer tool (Guides and configure e.g. AMR, Pulse, units) • Operation tool (walk-by) • Commissioning tool (Link location to serial number)

**Technical specifications,
Complete energy meter**

Application	Heating, cooling or combined heating and cooling*		
Medium	Water quality with pH 7 to 9.5 VDI 2035, VdTÜV TCh 1466		
Approvals, heating	EN1434 class 2 and 3, MID (DK-0200-MI004-034), CPA according to JJG225 -2010		
Approvals, cooling	Denmark: TS 27.02 010, Switzerland: METAS CH-T2-17763-01, Germany: PTB 17-22.001-DK, Austria: BEV-13.426_0078-E2_2017		
Measuring cycle	Flow: 0.5 sec. (SonoSelect 10), 2 sec. (SonoSafe 10) Energy: 0.5 sec. (SonoSelect 10), 2 sec. (SonoSafe 10) Temperature: 4 sec. (SonoSelect 10), 10 sec. (SonoSafe 10)		
Approved meteorological range	SonoSafe	SonoSelect	
	$\Delta\Theta$: 3- 90K Θ : 5- 95 °C	$\Delta\Theta$: 3 - 90K Θ : 5 - 95 °C	$\Delta\Theta$: 3 - 125K Θ : 5 - 130 °C
Temp. limits (energy calculation)	SonoSafe	SonoSelect	
	$\Delta\Theta$: 0.25 - 100K Θ : 0 - 105 °C	$\Delta\Theta$: 0.25 - 100K Θ : 0 - 105 °C	$\Delta\Theta$: 0.25 - 130K Θ : 0 - 140 °C
IP	65 (SonoSelect 10), 54 (SonoSafe 10)		
Cable strain relief	Withstand more than 5 kg		
Ambient operating temperature	Class A: 5 - 55° C indoor installation non condensing		
Ambient storage temperature	-25 - 60° C		
Temperature media	SonoSafe	SonoSelect	
	5-95 °C	5-95 °C	5-130 °C
Mechanical environment	Class M2		
Electromagnetic environment	Class E1		

* Bifunctional energy meters available only in approved meteorological range 5-95 °C

**Technical specifications,
Calculator**

Power supply	3.6 V DC lithium battery (2 AA SonoSelect 1 AA SonoSafe), Mains supply 230V AC	
Battery life time*	16+1 years (SonoSelect 10), 10+1 years (SonoSafe 10)	
Mains Supply	Voltage of Alternating Current	230V AC
	Upper and lower voltage tolerance	+10%/-15%
	Alternating current voltage frequency	50/60 Hz
	Power consumption	< 2.5VA
	Output	3.6V DC
	Backup supply	Integral SuperCap eliminates interruptions of Energy meter due to power failures for up to 60 Min.
	Cable gland	M12
Mains supply cable	2 wire with PHR3-2 connector for Mains supply	
Display	85 x 35 mm LCD display with 8 digits (11.5 mm high main characters) Menu guide and info panel 16 years of operation at q_p , 45 °C without display overflow	
Units	MWh - kWh - GJ - Gcal - °C - K - m ³ - m ³ /h - l/h	
Memory	4 years of data, yearly and monthly values stored (incl. pulse input) available as of FW01.06.00	
Optical interface	Optical acc. to EN62056-21. Data protocol acc. to EN13757-3, supports 2400 or 4800 baud.	
Communication	Wired M-Bus to EN13757-3, supports 300, 2400, 4800, 9600 baud. Delivered with 1 m cable (SonoSelect 10: PUR, SonoSafe 10: PVC) Serial number: sssssvvNNyyWW (addressing) ss : Primary address, yWWsssss : Secondary address	
Additional communication	1 slot for communication module (delivered from factory or later upgrade)	

* Battery life time measured under following preconditions: enclosure temp. 45° C, communication every 15 min. at 2400 baud or faster, 80 meters on bus. Please contact Danfoss for further information.

**Technical specifications,
Flow sensor**

DN	15	15	20	20	25	25	25	32
Nominal flow q_p (m ³ /h)	0.6	1.5	1.5	2.5	3.5	3.5	6.0	6.0
Max flow q_s (m ³ /h)	1.2	3	3	5	7	7	12	12
Minimum flow (1:100) q_i^* (m ³ /h)	0.006	0.015	0.015	0.025	0.035	0.035	0.06	0.06
Cut off flow q_c (m ³ /h)	0.0012	0.003	0.003	0.005	0.007	0.007	0.012	0.012
Overflow q_{ss} (m ³ /h)	1.32	3.3	3.3	5.5	7.7	7.7	12.3	12.3
Pressure drop (at q_p , 50 °C) (mBar)	30	150	150	160	130	130	220	220
K_{vs} values ($\Delta p=Q^2/K_{vs}^2$)	3.46	3.87		6.25	9.71	9.71	12.79	
Connection	G $\frac{3}{4}$ " 110mm		G1" 130mm		G1 $\frac{1}{4}$ " 160mm	G1 $\frac{1}{4}$ " 260mm	G1 $\frac{1}{4}$ " 260mm	G1 $\frac{1}{2}$ " 260mm
Pressure PN (bar)	16 (SonoSafe); 16 and 25 (SonoSelect)							
IP [EN60529]	65							
Temperature limits (°C)	0 to 105 (SonoSafe); 0 to 105 and 0 to 130 (SonoSelect)							
Cable length	1.5m (SonoSelect 10: PUR or silicone), 0.5m (SonoSafe 10: PVC)							
Mounting	Any position, no inlet or outlet restrictions							

* Technically prepared for 1:250 q_i

Technical specifications, Temperature sensor

Type	Pt1000 direct short, 2 wire		
Size	Diameter: Ø5.2 mm, length: 26 mm		
Nipple	M10 x 1 mm brass, with pin lock		
Cable length	1.5 m		
Accuracy	Class B (EN60751)		
Temperature range	SonoSafe	SonoSelect	
	5 to 95 °C	0 to 105 °C	0 to 150 °C
IP	65		
Approved temp. range to EN60751	SonoSafe	SonoSelect	
	Ø: 0 - 105 °C	Ø: 0 - 105 °C	Ø: 0 - 150 °C
Difference temp. EN60751	SonoSafe	SonoSelect	
	ΔØ:3 - 105 K	ΔØ:3 - 105 K	ΔØ:3 - 150 K
Pressure	25 bar		

Communication modules

Modules in general

To adapt the meter for various applications SonoSelect 10 and SonoSafe 10 features a slot for mounting communication modules. Each module features its own μ -controller and is powered by its own battery. Modules have their own parameter set which is saved in the module μ -controller flash memory. A local copy of the energy meter parameters used for communication is stored in the module. Data from module is updated in meter every 10 minutes.

Power: Lithium Thionyl Chloride battery (half of AA size) or Mains power supply (230 V).

2 pulse in/outputs have common ground.

Modules are galvanically isolated from main Energy Meter circuitry.

Wired M-Bus module with 2 pulse inputs

Once installed the meter will display the icon for wired communication and pulse inputs in loop 2 of the display. Wired M-Bus is galvanically isolated from μ -controller and pulse inputs. The two pulse inputs can be programmed independently of each other (see specification for pulse input module).

M-Bus (primary)	Lithium Thionyl Chloride battery (half of AA size)
M-Bus (secondary)	M-Bus supply
Baud rate supported	300, 2400, 4800, 9600
Communication protocol	According to EN1434-3 & EN13757-3
Battery life time	16+1 year
Addressing	Serial number: sssssvvNNyyWW ss : Primary address, yWWsssss : Secondary address

Wireless OMS communication module, 868.95MHz with 2 pulse inputs

Once installed the meter will display the icon for wireless communication and pulse inputs in loop 2 of the display. The two pulse inputs can be programmed independently of each other (see specification for pulse input module).

Standard	Open Metering System (OMS) issue 4.0.2
Frequency	868.95 MHz
Antenna	Internal
Transmission power	10mW (Max. 25mW; 13,9 dBm)
Mode	T1 mode
Encryption	AES 128 bit encryption (mode 5), Parameterized Static key
Sending interval	Fixed network: 15 min.
Telegram	Standard telegram*
Battery life time	16+1 year (with pulse inputs off)
Addressing	Serial number: sssssvvNNyyWW yWWsssss : Secondary address

* See section with data telegram.

2 pulse input module

Once installed the meter will display the icon for pulse inputs in loop 2 of the display. Accumulated volume is only readable by communication. The two pulse inputs can be programmed independently of each other.

Pulse value	0.001 m ³ to 1 m ³ per pulse
Voltage supply	≤ 6.0 V
Source current	≤ 0.1 mA
High level input threshold	≥ 2 V
Low level input threshold	≤ 0.5 V
Pull-up resistor	100 kΩ
Pulse length	≥100 ms
Maximum frequency	≤ 5 Hz
Pulse inputs	According to EN1434-2, section 7.1.5 (Classification of pulse input devices Class IB)*
Battery life time	16+1 year

* Suitable for both electronic switch and Reed contact.

Communication modules (continuous)

2 pulse output module

Once installed the meter will display the icon for wired communication in loop 2 of the display.

Pulse 1 (energy*)	+ terminal 16, - terminal 17
Pulse 2 (volume*)	+ terminal 18, - terminal 19
Pulse value*	Unit follow the display. Scaling follow least significant digit of the display (default setting can be changed via SonoApp)
Pulse timing	Updates every 15 seconds
Polarity reversal:	Not possible, but can withstand -30V, max 27 mA without damage
Pulse length	≥100 ms
Pulse Pause:	≥100 ms
Voltage supply	3-30 V
Source current	≤ 27 mA
"ON" condition	U<2,0 @ 27 mA
"OFF" condition	R>=6 MΩ
Maximum frequency	≤ 5 Hz
Pulse outputs	According to EN1434-2, section 8.2.3 (Classification of pulse output devices Class OB)
Battery life time	16+1 year
Cable length	Max 25 m
Alarms	E32 is activated in meter if: 1) Module battery is empty 2) When no. of delayed pulses exceeds 5000 (incorrect scaling)

*Default setting. Can be changed via SonoApp

Data telegram

<p>Wired M-bus Standard telegram (16 seconds if main powered):</p> <ul style="list-style-type: none"> Accumulated Energy (heat and cooling for bifunctional) Accumulated Volume (heat and cooling for bifunctional) Current flow Current power Supply temperature Return temperature Difference temperature Enclosure temperature Current time Hour counter factory Hour counter OK 	<p>Wireless M-bus (OMS) Standard telegram fixed network (15 minutes sending interval, 16 seconds if mains powered):</p> <ul style="list-style-type: none"> Accumulated Energy (heat and cooling for bifunctional) Accumulated Volume (heat and cooling for bifunctional) Current flow Current power Supply Temperature Return Temperature Current Time 	<p>Wireless M-Bus (Walk -by) Standard telegram Walk by (2 minutes sending interval, 16 seconds if mains powered):</p> <ul style="list-style-type: none"> Accumulated Energy (heat and cooling for bifunctional) Accumulated Volume (heat and cooling for bifunctional) Current Time Hour counter factory Month log 1 (last month log)
---	--	---

Note! Default setting can be changed via SonoApp

Bifunctional meters

Bifunctional meters are for combined heating and cooling applications. θ_{hc} default value is 30 °C it can be configured with SonoApp. Bifunctional energy meters available only in approved meteorological range 5-95 °C.

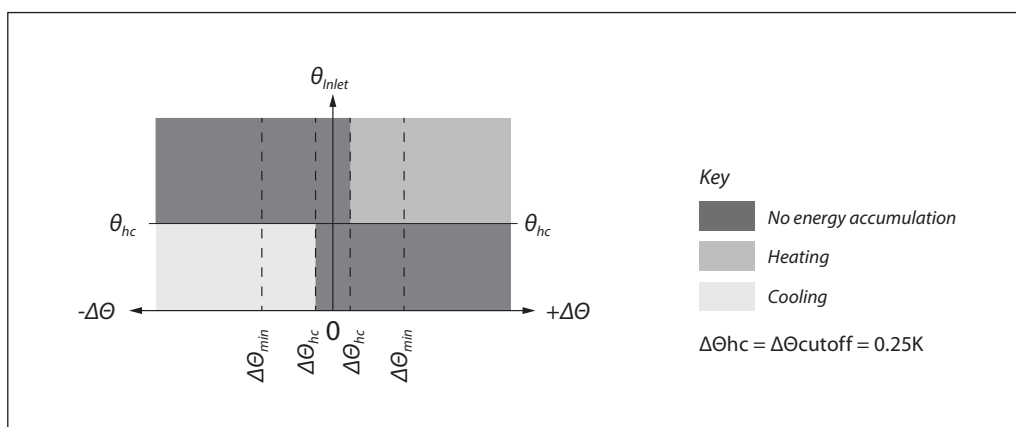

Application drawings

Heat meters have red temp sensor in supply pipe and all cooling meters have blue temp sensor in supply pipe

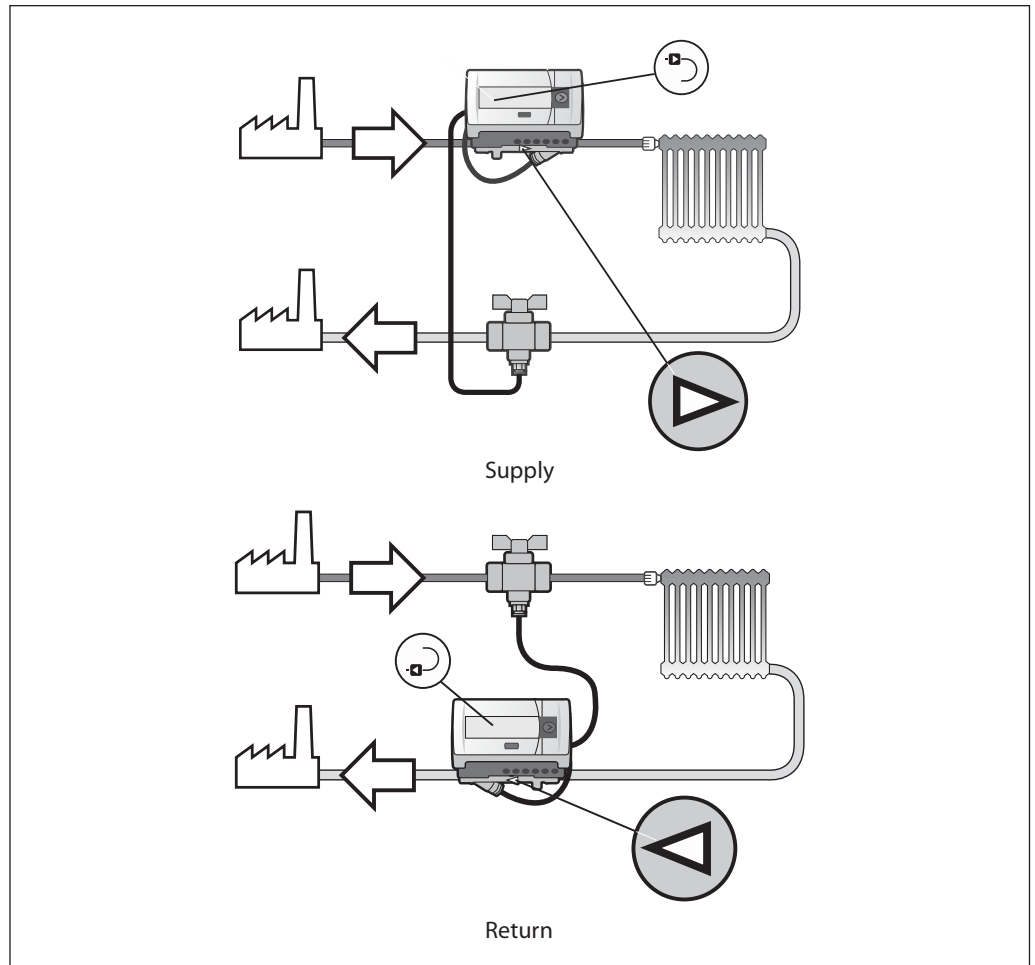

Accuracy

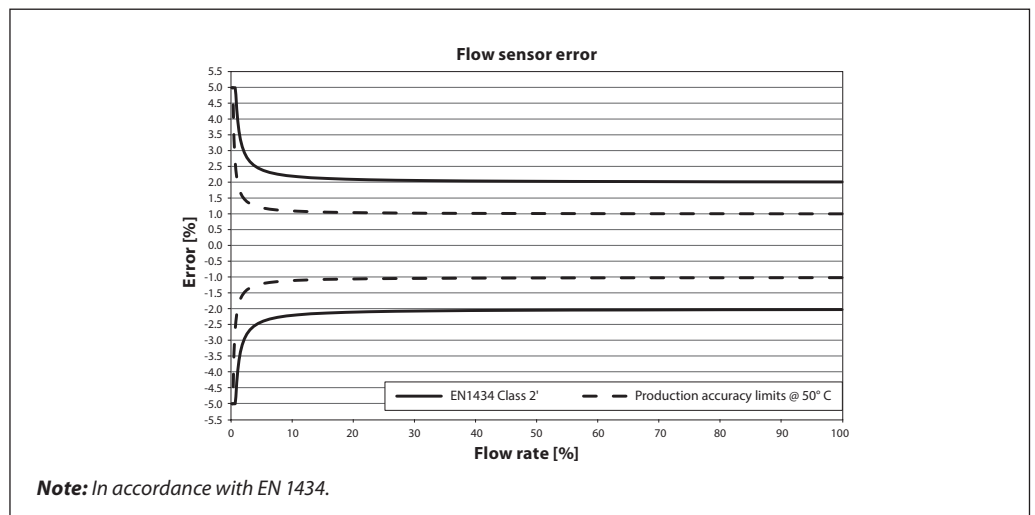

Pressure loss

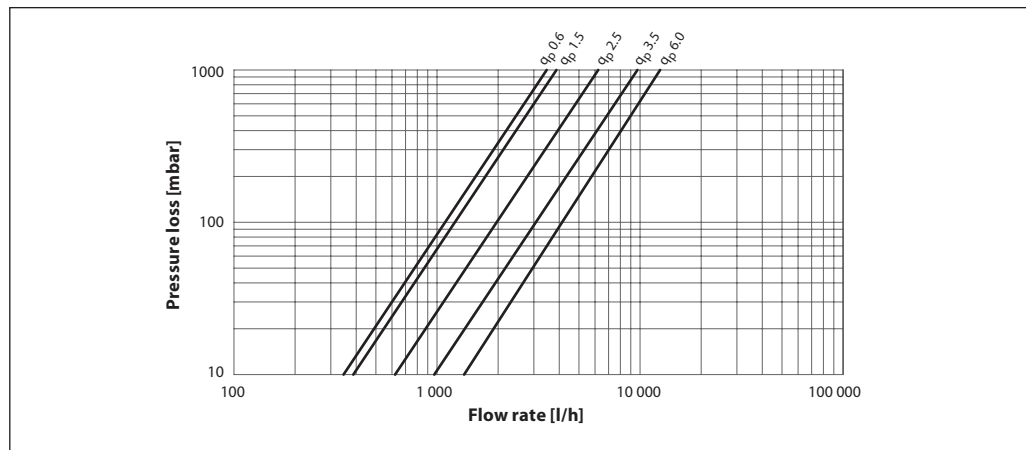

Menu structure

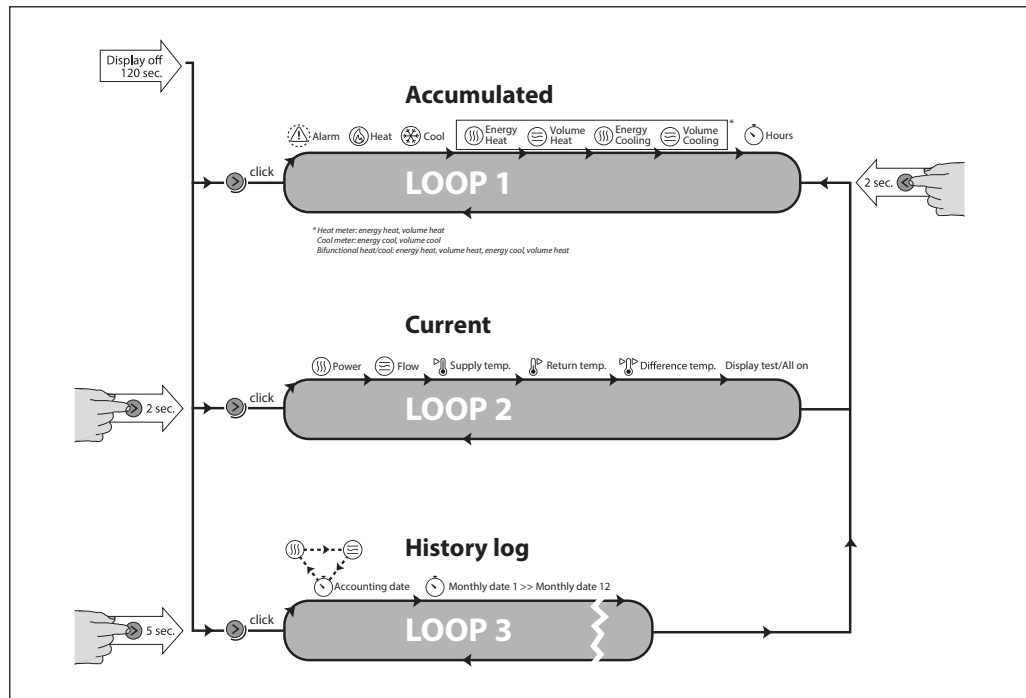

Mounting

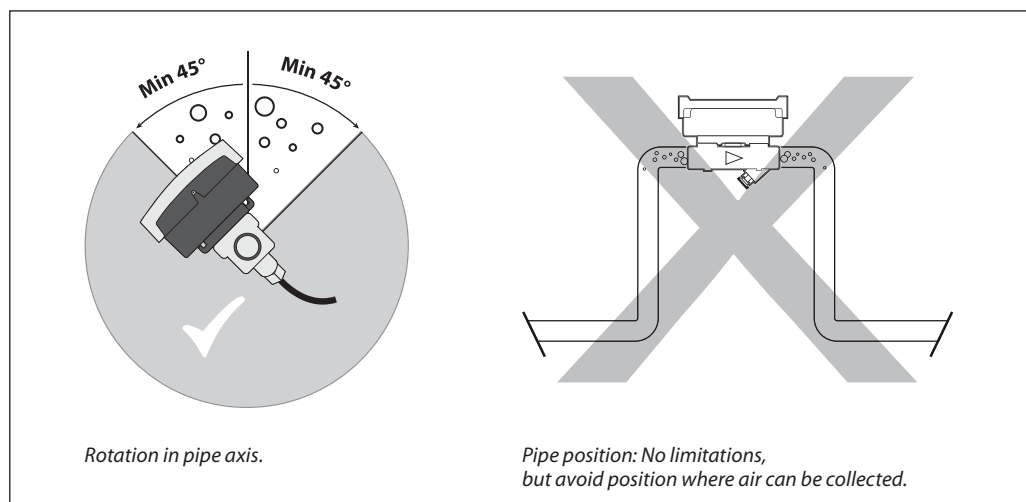

Dimensions

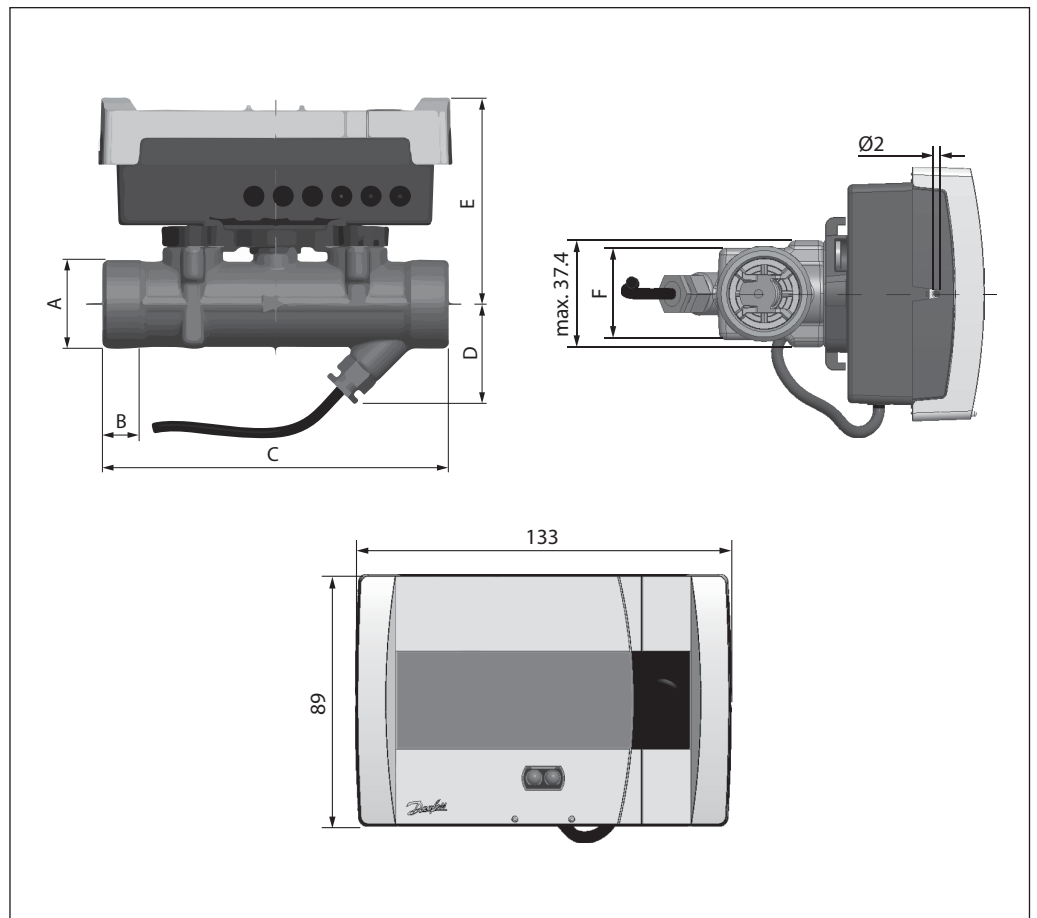

Dimension	DN15	DN20	DN20 + extension pipe 014U1957	DN25	DN25	DN32
A	G¾A	G1A	G1A	G1¼ A	G1¼ A	G1½A
B	12 mm	14 mm	14 mm	16 mm	16 mm	18 mm
C	110 mm	130 mm	190 mm	160 mm	260 mm	260 mm
D	33.5 mm	38 mm	38 mm	40.5 mm	40.5 mm	40.5 mm
E	74.5 mm	77.5 mm	77.5 mm	80.5 mm	80.5 mm	80.5 mm
F	32 mm	32 mm	32 mm	41 mm	41 mm	41 mm
Weight	700 g	800 g	1100 g	1100 g	1500 g	1600 g

Ordering
SonoSelect 10 - Heating

Meter size	PN	Installation	Temperature Range [°C]	Cable length temperature sensor	Power supply	Integrated communication	Modules	Energy unit	Code No.
DN15 qp0.6m ³ /h G $\frac{3}{4}$ 110mm	PN16	Return	5-95°C	PUR 1.5m	Battery 3.6V DC (2 AA-cell)	None	Radio OMS 868,95 with 2 pulse inputs	kWh	014U0068
		Supply	5-95°C	PUR 1.5m	Battery 3.6V DC (2 AA-cell)	None	Radio OMS 868,95 with 2 pulse inputs	kWh	014U0069
		Supply	5-95°C	PUR 1.5m	Battery 3.6V DC (2 AA-cell)	None	Radio OMS 868,95 with 2 pulse inputs	GJ	014U0070
		Return	5-95°C	PUR 1.5m	Battery 3.6V DC (2 AA-cell)	None	Radio OMS 868,95 with 2 pulse inputs	GJ	014U0071
		Return	5-95°C	PUR 1.5m	Battery 3.6V DC (2 AA-cell)	Wired M-Bus	No module	kWh	014U0165
		Supply	5-95°C	PUR 1.5m	Battery 3.6V DC (2 AA-cell)	Wired M-Bus	No module	kWh	014U0166
		Return	5-95°C	PUR 1.5m	Battery 3.6V DC (2 AA-cell)	Wired M-Bus	2 pulse inputs	kWh	014U0183
		Supply	5-95°C	PUR 1.5m	Battery 3.6V DC (2 AA-cell)	Wired M-Bus	2 pulse inputs	kWh	014U0184
		Return	5-95°C	PUR 1.5m	Battery 3.6V DC (2 AA-cell)	None	Radio OMS WB 868,95 with 2 pulse inputs	kWh	014U0324
		Return	5-95°C	PUR 1.5m	Mains power 230V	None	Radio OMS 868,95 with 2 pulse inputs	kWh	014U0338
		Supply	5-95°C	PUR 1.5m	Mains power 230V	None	Radio OMS 868,95 with 2 pulse inputs	kWh	014U0339
		Return	5-95°C	PUR 1.5m	Mains power 230V	Wired M-Bus	No module	kWh	014U0449
		Supply	5-95°C	PUR 1.5m	Mains power 230V	Wired M-Bus	No module	kWh	014U0450
		PN25	Return	5-130°C	silicone 1.5m	Battery 3.6V DC (2 AA-cell)	None	Radio OMS 868,95 with 2 pulse inputs	kWh
Supply	5-130°C		silicone 1.5m	Battery 3.6V DC (2 AA-cell)	None	Radio OMS 868,95 with 2 pulse inputs	kWh	014U0406	
Return	5-130°C		silicone 1.5m	Battery 3.6V DC (2 AA-cell)	Wired M-Bus	No module	kWh	014U0419	
Supply	5-130°C		silicone 1.5m	Battery 3.6V DC (2 AA-cell)	Wired M-Bus	No module	kWh	014U0420	
Return	5-130°C		silicone 1.5m	Battery 3.6V DC (2 AA-cell)	Wired M-Bus	2 pulse inputs	kWh	014U0433	
Supply	5-130°C		silicone 1.5m	Battery 3.6V DC (2 AA-cell)	Wired M-Bus	2 pulse inputs	kWh	014U0434	
Return	5-130°C		silicone 1.5m	Mains power 230V	Wired M-Bus	No module	kWh	014U0542	
Supply	5-130°C		silicone 1.5m	Mains power 230V	Wired M-Bus	No module	kWh	014U0543	
DN15 qp1.5m ³ /h G $\frac{3}{4}$ 110mm	PN16	Return	5-95°C	PUR 1.5m	Battery 3.6V DC (2 AA-cell)	None	Radio OMS 868,95 with 2 pulse inputs	kWh	014U0081
		Supply	5-95°C	PUR 1.5m	Battery 3.6V DC (2 AA-cell)	None	Radio OMS 868,95 with 2 pulse inputs	kWh	014U0082
		Supply	5-95°C	PUR 1.5m	Battery 3.6V DC (2 AA-cell)	None	Radio OMS 868,95 with 2 pulse inputs	GJ	014U0083
		Return	5-95°C	PUR 1.5m	Battery 3.6V DC (2 AA-cell)	None	Radio OMS 868,95 with 2 pulse inputs	GJ	014U0084
		Return	5-95°C	PUR 1.5m	Battery 3.6V DC (2 AA-cell)	Wired M-Bus	No module	kWh	014U0167
		Supply	5-95°C	PUR 1.5m	Battery 3.6V DC (2 AA-cell)	Wired M-Bus	No module	kWh	014U0168
		Return	5-95°C	PUR 1.5m	Battery 3.6V DC (2 AA-cell)	Wired M-Bus	2 pulse inputs	kWh	014U0185
		Supply	5-95°C	PUR 1.5m	Battery 3.6V DC (2 AA-cell)	Wired M-Bus	2 pulse inputs	kWh	014U0186
		Return	5-95°C	PUR 1.5m	Battery 3.6V DC (2 AA-cell)	Wired M-Bus	Wired M-Bus with 2 pulse inputs	kWh	014U0247
		Return	5-95°C	PUR 1.5m	Battery 3.6V DC (2 AA-cell)	None	Radio OMS WB 868,95 with 2 pulse inputs	kWh	014U0253
		Return	5-95°C	PUR 3.0m	Battery 3.6V DC (2 AA-cell)	None	Radio OMS WB 868,95 with 2 pulse inputs	kWh	014U0326
		Return	5-95°C	PUR 1.5m	Mains power 230V	None	Radio OMS 868,95 with 2 pulse inputs	kWh	014U0340
		Supply	5-95°C	PUR 1.5m	Mains power 230V	None	Radio OMS 868,95 with 2 pulse inputs	kWh	014U0341
		Return	5-95°C	PUR 1.5m	Mains power 230V	Wired M-Bus	Wired M-Bus with 2 pulse inputs	kWh	014U0350
		Return	5-95°C	PUR 1.5m	Mains power 230V	Wired M-Bus	No module	kWh	014U0451
		Supply	5-95°C	PUR 1.5m	Mains power 230V	Wired M-Bus	No module	kWh	014U0452
		Return	5-95°C	PUR 5.0m	Battery 3.6V DC (2 AA-cell)	Wired M-Bus	Wired M-Bus with 2 pulse inputs	kWh	014U0495
		PN25	Return	5-130°C	silicone 1.5m	Battery 3.6V DC (2 AA-cell)	None	Radio OMS 868,95 with 2 pulse inputs	kWh
Supply	5-130°C		silicone 1.5m	Battery 3.6V DC (2 AA-cell)	None	Radio OMS 868,95 with 2 pulse inputs	kWh	014U0408	
Return	5-130°C		silicone 1.5m	Battery 3.6V DC (2 AA-cell)	Wired M-Bus	No module	kWh	014U0421	
Supply	5-130°C		silicone 1.5m	Battery 3.6V DC (2 AA-cell)	Wired M-Bus	No module	kWh	014U0422	
Return	5-130°C		silicone 1.5m	Battery 3.6V DC (2 AA-cell)	Wired M-Bus	2 pulse inputs	kWh	014U0435	

Ordering

SonoSelect 10 - Heating (continuous)

Meter size	PN	Installation	Temperature Range [°]	Cable length temperature sensor	Power supply	Integrated communication	Modules	Energy unit	Code No.
DN15 qp1.5m ³ /h G ^{3/4} 110mm	PN25	Supply	5-130°C	silicone 1.5m	Battery 3.6V DC (2 AA-cell)	Wired M-Bus	2 pulse inputs	kWh	014U0436
		Return	5-130°C	silicone 1.5m	Mains power 230V	Wired M-Bus	No module	kWh	014U0544
		Supply	5-130°C	silicone 1.5m	Mains power 230V	Wired M-Bus	No module	kWh	014U0545
DN20 qp1.5m ³ /h G1 130mm	PN16	Return	5-95°C	PUR 1.5m	Battery 3.6V DC (2 AA-cell)	None	Radio OMS 868,95 with 2 pulse inputs	kWh	014U0094
		Supply	5-95°C	PUR 1.5m	Battery 3.6V DC (2 AA-cell)	None	Radio OMS 868,95 with 2 pulse inputs	kWh	014U0095
		Supply	5-95°C	PUR 1.5m	Battery 3.6V DC (2 AA-cell)	None	Radio OMS 868,95 with 2 pulse inputs	GJ	014U0096
		Return	5-95°C	PUR 1.5m	Battery 3.6V DC (2 AA-cell)	None	Radio OMS 868,95 with 2 pulse inputs	GJ	014U0097
		Return	5-95°C	PUR 1.5m	Battery 3.6V DC (2 AA-cell)	Wired M-Bus	No module	kWh	014U0169
		Supply	5-95°C	PUR 1.5m	Battery 3.6V DC (2 AA-cell)	Wired M-Bus	No module	kWh	014U0170
		Return	5-95°C	PUR 1.5m	Battery 3.6V DC (2 AA-cell)	Wired M-Bus	2 pulse inputs	kWh	014U0187
		Supply	5-95°C	PUR 1.5m	Battery 3.6V DC (2 AA-cell)	Wired M-Bus	2 pulse inputs	kWh	014U0188
		Return	5-95°C	PUR 1.5m	Battery 3.6V DC (2 AA-cell)	Wired M-Bus	Wired M-Bus with 2 pulse inputs	kWh	014U0248
		Return	5-95°C	PUR 1.5m	Mains power 230V	None	Radio OMS 868,95 with 2 pulse inputs	kWh	014U0342
		Supply	5-95°C	PUR 1.5m	Mains power 230V	None	Radio OMS 868,95 with 2 pulse inputs	kWh	014U0343
		Return	5-95°C	PUR 1.5m	Mains power 230V	Wired M-Bus	Wired M-Bus with 2 pulse inputs	kWh	014U0351
	Return	5-95°C	PUR 1.5m	Mains power 230V	Wired M-Bus	No module	kWh	014U0453	
	Supply	5-95°C	PUR 1.5m	Mains power 230V	Wired M-Bus	No module	kWh	014U0454	
	PN25	Return	5-130°C	silicone 1.5m	Battery 3.6V DC (2 AA-cell)	None	Radio OMS 868,95 with 2 pulse inputs	kWh	014U0409
		Supply	5-130°C	silicone 1.5m	Battery 3.6V DC (2 AA-cell)	None	Radio OMS 868,95 with 2 pulse inputs	kWh	014U0410
		Return	5-130°C	silicone 1.5m	Battery 3.6V DC (2 AA-cell)	Wired M-Bus	No module	kWh	014U0423
		Supply	5-130°C	silicone 1.5m	Battery 3.6V DC (2 AA-cell)	Wired M-Bus	No module	kWh	014U0424
		Return	5-130°C	silicone 1.5m	Battery 3.6V DC (2 AA-cell)	Wired M-Bus	2 pulse inputs	kWh	014U0437
		Supply	5-130°C	silicone 1.5m	Battery 3.6V DC (2 AA-cell)	Wired M-Bus	2 pulse inputs	kWh	014U0438
Return		5-130°C	silicone 1.5m	Mains power 230V	Wired M-Bus	No module	kWh	014U0546	
Supply		5-130°C	silicone 1.5m	Mains power 230V	Wired M-Bus	No module	kWh	014U0547	
DN20 qp2.5m ³ /h G1 130mm	PN16	Return	5-95°C	PUR 1.5m	Battery 3.6V DC (2 AA-cell)	None	Radio OMS 868,95 with 2 pulse inputs	kWh	014U0107
		Supply	5-95°C	PUR 1.5m	Battery 3.6V DC (2 AA-cell)	None	Radio OMS 868,95 with 2 pulse inputs	kWh	014U0108
		Supply	5-95°C	PUR 1.5m	Battery 3.6V DC (2 AA-cell)	None	Radio OMS 868,95 with 2 pulse inputs	GJ	014U0109
		Return	5-95°C	PUR 1.5m	Battery 3.6V DC (2 AA-cell)	None	Radio OMS 868,95 with 2 pulse inputs	GJ	014U0110
		Return	5-95°C	PUR 1.5m	Battery 3.6V DC (2 AA-cell)	Wired M-Bus	No module	kWh	014U0171
		Supply	5-95°C	PUR 1.5m	Battery 3.6V DC (2 AA-cell)	Wired M-Bus	No module	kWh	014U0172
		Return	5-95°C	PUR 1.5m	Battery 3.6V DC (2 AA-cell)	Wired M-Bus	2 pulse inputs	kWh	014U0189
		Supply	5-95°C	PUR 1.5m	Battery 3.6V DC (2 AA-cell)	Wired M-Bus	2 pulse inputs	kWh	014U0190
		Return	5-95°C	PUR 1.5m	Battery 3.6V DC (2 AA-cell)	Wired M-Bus	Wired M-Bus with 2 pulse inputs	kWh	014U0249
		Return	5-95°C	PUR 1.5m	Battery 3.6V DC (2 AA-cell)	None	Radio OMS WB 868,95 with 2 pulse inputs	kWh	014U0325
		Return	5-95°C	PUR 3.0m	Battery 3.6V DC (2 AA-cell)	None	Radio OMS WB 868,95 with 2 pulse inputs	kWh	014U0327
		Return	5-95°C	PUR 1.5m	Mains power 230V	None	Radio OMS 868,95 with 2 pulse inputs	kWh	014U0344
		Supply	5-95°C	PUR 1.5m	Mains power 230V	None	Radio OMS 868,95 with 2 pulse inputs	kWh	014U0345
		Return	5-95°C	PUR 1.5m	Mains power 230V	Wired M-Bus	Wired M-Bus with 2 pulse inputs	kWh	014U0352
		Return	5-95°C	PUR 1.5m	Mains power 230V	Wired M-Bus	No module	kWh	014U0455
		Supply	5-95°C	PUR 1.5m	Mains power 230V	Wired M-Bus	No module	kWh	014U0456
		Return	5-95°C	PUR 5.0m	Battery 3.6V DC (2 AA-cell)	Wired M-Bus	Wired M-Bus with 2 pulse inputs	kWh	014U0496

Ordering

SonoSelect 10 - Heating (continuous)

Meter size	PN	Installation	Temperature Range [°]	Cable length temperature sensor	Power supply	Integrated communication	Modules	Energy unit	Code No.
DN20 qp2.5m ³ /h G1 130mm	PN25	Return	5-130°C	silicone 1.5m	Battery 3.6V DC (2 AA-cell)	None	Radio OMS 868,95 with 2 pulse inputs	kWh	014U0411
		Supply	5-130°C	silicone 1.5m	Battery 3.6V DC (2 AA-cell)	None	Radio OMS 868,95 with 2 pulse inputs	kWh	014U0412
		Return	5-130°C	silicone 1.5m	Battery 3.6V DC (2 AA-cell)	Wired M-Bus	No module	kWh	014U0425
		Supply	5-130°C	silicone 1.5m	Battery 3.6V DC (2 AA-cell)	Wired M-Bus	No module	kWh	014U0426
		Return	5-130°C	silicone 1.5m	Battery 3.6V DC (2 AA-cell)	Wired M-Bus	2 pulse inputs	kWh	014U0439
		Supply	5-130°C	silicone 1.5m	Battery 3.6V DC (2 AA-cell)	Wired M-Bus	2 pulse inputs	kWh	014U0440
		Return	5-130°C	silicone 1.5m	Mains power 230V	Wired M-Bus	No module	kWh	014U0548
Supply	5-130°C	silicone 1.5m	Mains power 230V	Wired M-Bus	No module	kWh	014U0549		
DN25 qp3.5m ³ /h G1¼ 160mm	PN16	Return	5-95°C	PUR 1.5m	Battery 3.6V DC (2 AA-cell)	None	Radio OMS 868,95 with 2 pulse inputs	kWh	014U0120
		Supply	5-95°C	PUR 1.5m	Battery 3.6V DC (2 AA-cell)	None	Radio OMS 868,95 with 2 pulse inputs	kWh	014U0121
		Supply	5-95°C	PUR 1.5m	Battery 3.6V DC (2 AA-cell)	None	Radio OMS 868,95 with 2 pulse inputs	GJ	014U0122
		Return	5-95°C	PUR 1.5m	Battery 3.6V DC (2 AA-cell)	None	Radio OMS 868,95 with 2 pulse inputs	GJ	014U0123
		Return	5-95°C	PUR 1.5m	Battery 3.6V DC (2 AA-cell)	Wired M-Bus	No module	kWh	014U0173
		Supply	5-95°C	PUR 1.5m	Battery 3.6V DC (2 AA-cell)	Wired M-Bus	No module	kWh	014U0174
		Return	5-95°C	PUR 1.5m	Battery 3.6V DC (2 AA-cell)	Wired M-Bus	2 pulse inputs	kWh	014U0191
		Supply	5-95°C	PUR 1.5m	Battery 3.6V DC (2 AA-cell)	Wired M-Bus	2 pulse inputs	kWh	014U0192
		Return	5-95°C	PUR 1.5m	Battery 3.6V DC (2 AA-cell)	None	Radio OMS WB 868,95 with 2 pulse inputs	kWh	014U0335
		Return	5-95°C	PUR 1.5m	Mains power 230V	Wired M-Bus	No module	kWh	014U0457
		Supply	5-95°C	PUR 1.5m	Mains power 230V	Wired M-Bus	No module	kWh	014U0458
DN25 qp3.5m ³ /h G1¼ 260mm	PN16	Return	5-95°C	PUR 1.5m	Battery 3.6V DC (2 AA-cell)	None	Radio OMS 868,95 with 2 pulse inputs	kWh	014U0133
		Supply	5-95°C	PUR 1.5m	Battery 3.6V DC (2 AA-cell)	None	Radio OMS 868,95 with 2 pulse inputs	kWh	014U0134
		Supply	5-95°C	PUR 1.5m	Battery 3.6V DC (2 AA-cell)	None	Radio OMS 868,95 with 2 pulse inputs	GJ	014U0135
		Return	5-95°C	PUR 1.5m	Battery 3.6V DC (2 AA-cell)	None	Radio OMS 868,95 with 2 pulse inputs	GJ	014U0136
		Return	5-95°C	PUR 1.5m	Mains power 230V	None	Radio OMS 868,95 with 2 pulse inputs	kWh	014U0346
		Supply	5-95°C	PUR 1.5m	Mains power 230V	None	Radio OMS 868,95 with 2 pulse inputs	kWh	014U0347
		Return	5-95°C	PUR 1.5m	Battery 3.6V DC (2 AA-cell)	Wired M-Bus	No module	kWh	014U0447
		Supply	5-95°C	PUR 1.5m	Battery 3.6V DC (2 AA-cell)	Wired M-Bus	No module	kWh	014U0448
		Return	5-95°C	PUR 1.5m	Mains power 230V	Wired M-Bus	No module	kWh	014U0459
	Supply	5-95°C	PUR 1.5m	Mains power 230V	Wired M-Bus	No module	kWh	014U0460	
	PN25	Return	5-130°C	silicone 1.5m	Battery 3.6V DC (2 AA-cell)	None	Radio OMS 868,95 with 2 pulse inputs	kWh	014U0413
		Supply	5-130°C	silicone 1.5m	Battery 3.6V DC (2 AA-cell)	None	Radio OMS 868,95 with 2 pulse inputs	kWh	014U0414
		Return	5-130°C	silicone 1.5m	Battery 3.6V DC (2 AA-cell)	Wired M-Bus	No module	kWh	014U0427
		Supply	5-130°C	silicone 1.5m	Battery 3.6V DC (2 AA-cell)	Wired M-Bus	No module	kWh	014U0428
		Return	5-130°C	silicone 1.5m	Battery 3.6V DC (2 AA-cell)	Wired M-Bus	2 pulse inputs	kWh	014U0441
		Supply	5-130°C	silicone 1.5m	Battery 3.6V DC (2 AA-cell)	Wired M-Bus	2 pulse inputs	kWh	014U0442
		Return	5-130°C	silicone 1.5m	Mains power 230V	Wired M-Bus	No module	kWh	014U0550
		Supply	5-130°C	silicone 1.5m	Mains power 230V	Wired M-Bus	No module	kWh	014U0551

Ordering

SonoSelect 10 - Heating (continuous)

Meter size	PN	Installation	Temperature Range [°]	Cable length temperature sensor	Power supply	Integrated communication	Modules	Energy unit	Code No.
DN25 qp6.0m ³ /h G1¼ 260mm	PN16	Return	5-95°C	PUR 1.5m	Battery 3.6V DC (2 AA-cell)	None	Radio OMS 868,95 with 2 pulse inputs	kWh	014U0268
		Supply	5-95°C	PUR 1.5m	Battery 3.6V DC (2 AA-cell)	None	Radio OMS 868,95 with 2 pulse inputs	kWh	014U0269
		Return	5-95°C	PUR 1.5m	Battery 3.6V DC (2 AA-cell)	Wired M-Bus	2 pulse inputs	kWh	014U0270
		Supply	5-95°C	PUR 1.5m	Battery 3.6V DC (2 AA-cell)	Wired M-Bus	2 pulse inputs	kWh	014U0271
		Return	5-95°C	PUR 1.5m	Battery 3.6V DC (2 AA-cell)	Wired M-Bus	No module	kWh	014U0272
		Supply	5-95°C	PUR 1.5m	Battery 3.6V DC (2 AA-cell)	Wired M-Bus	No module	kWh	014U0273
		Return	5-95°C	PUR 3.0m	Battery 3.6V DC (2 AA-cell)	None	Radio OMS WB 868,95 with 2 pulse inputs	kWh	014U0328
		Return	5-95°C	PUR 1.5m	Battery 3.6V DC (2 AA-cell)	None	Radio OMS WB 868,95 with 2 pulse inputs	kWh	014U0336
		Return	5-95°C	PUR 1.5m	Mains power 230V	None	Radio OMS 868,95 with 2 pulse inputs	kWh	014U0348
		Supply	5-95°C	PUR 1.5m	Mains power 230V	None	Radio OMS 868,95 with 2 pulse inputs	kWh	014U0349
	Return	5-95°C	PUR 1.5m	Mains power 230V	Wired M-Bus	No module	kWh	014U0461	
	Supply	5-95°C	PUR 1.5m	Mains power 230V	Wired M-Bus	No module	kWh	014U0462	
	PN25	Return	5-130°C	silicone 1.5m	Battery 3.6V DC (2 AA-cell)	None	Radio OMS 868,95 with 2 pulse inputs	kWh	014U0415
		Supply	5-130°C	silicone 1.5m	Battery 3.6V DC (2 AA-cell)	None	Radio OMS 868,95 with 2 pulse inputs	kWh	014U0416
		Return	5-130°C	silicone 1.5m	Battery 3.6V DC (2 AA-cell)	Wired M-Bus	No module	kWh	014U0429
		Supply	5-130°C	silicone 1.5m	Battery 3.6V DC (2 AA-cell)	Wired M-Bus	No module	kWh	014U0430
		Return	5-130°C	silicone 1.5m	Battery 3.6V DC (2 AA-cell)	Wired M-Bus	2 pulse inputs	kWh	014U0443
		Supply	5-130°C	silicone 1.5m	Battery 3.6V DC (2 AA-cell)	Wired M-Bus	2 pulse inputs	kWh	014U0444
Return		5-130°C	silicone 1.5m	Mains power 230V	Wired M-Bus	No module	kWh	014U0552	
Supply		5-130°C	silicone 1.5m	Mains power 230V	Wired M-Bus	No module	kWh	014U0553	
DN32 qp6.0m ³ /h G1½ 260mm	PN16	Return	5-95°C	PUR 1.5m	Battery 3.6V DC (2 AA-cell)	None	Radio OMS 868,95 with 2 pulse inputs	kWh	014U0278
		Supply	5-95°C	PUR 1.5m	Battery 3.6V DC (2 AA-cell)	None	Radio OMS 868,95 with 2 pulse inputs	kWh	014U0279
		Return	5-95°C	PUR 1.5m	Battery 3.6V DC (2 AA-cell)	Wired M-Bus	2 pulse inputs	kWh	014U0280
		Supply	5-95°C	PUR 1.5m	Battery 3.6V DC (2 AA-cell)	Wired M-Bus	2 pulse inputs	kWh	014U0281
		Return	5-95°C	PUR 1.5m	Battery 3.6V DC (2 AA-cell)	Wired M-Bus	No module	kWh	014U0282
		Supply	5-95°C	PUR 1.5m	Battery 3.6V DC (2 AA-cell)	Wired M-Bus	No module	kWh	014U0283
		Return	5-95°C	PUR 1.5m	Battery 3.6V DC (2 AA-cell)	None	Radio OMS WB 868,95 with 2 pulse inputs	kWh	014U0337
		Return	5-95°C	PUR 1.5m	Mains power 230V	Wired M-Bus	No module	kWh	014U0463
	Supply	5-95°C	PUR 1.5m	Mains power 230V	Wired M-Bus	No module	kWh	014U0464	
	PN25	Return	5-130°C	silicone 1.5m	Battery 3.6V DC (2 AA-cell)	None	Radio OMS 868,95 with 2 pulse inputs	kWh	014U0417
		Supply	5-130°C	silicone 1.5m	Battery 3.6V DC (2 AA-cell)	None	Radio OMS 868,95 with 2 pulse inputs	kWh	014U0418
		Return	5-130°C	silicone 1.5m	Battery 3.6V DC (2 AA-cell)	Wired M-Bus	No module	kWh	014U0431
		Supply	5-130°C	silicone 1.5m	Battery 3.6V DC (2 AA-cell)	Wired M-Bus	No module	kWh	014U0432
		Return	5-130°C	silicone 1.5m	Battery 3.6V DC (2 AA-cell)	Wired M-Bus	2 pulse inputs	kWh	014U0445
		Supply	5-130°C	silicone 1.5m	Battery 3.6V DC (2 AA-cell)	Wired M-Bus	2 pulse inputs	kWh	014U0446
		Return	5-130°C	silicone 1.5m	Mains power 230V	Wired M-Bus	No module	kWh	014U0554
		Supply	5-130°C	silicone 1.5m	Mains power 230V	Wired M-Bus	No module	kWh	014U0555

Ordering
SonoSafe 10 - Heating

Meter size	PN	Installation	Temperature Range [°]	Cable length temperature sensor	Power supply	Integrated communication	Modules	Energy unit	Code No.
DN15 qp0.6m ³ /h G ³ / ₄ 110mm	PN16	Return	5-95°C	PVC 1.5m	Battery 3.6V DC (1 AA-cell)	None	No module	kWh	014U0001
		Supply	5-95°C	PVC 1.5m	Battery 3.6V DC (1 AA-cell)	None	No module	kWh	014U0002
		Supply	5-95°C	PVC 1.5m	Battery 3.6V DC (1 AA-cell)	None	No module	GJ	014U0026
		Return	5-95°C	PVC 1.5m	Battery 3.6V DC (1 AA-cell)	None	No module	GJ	014U0027
		Return	5-95°C	PVC 1.5m	Battery 3.6V DC (1 AA-cell)	None	Radio OMS 868,95 with 2 pulse inputs	kWh	014U0235
		Supply	5-95°C	PVC 1.5m	Battery 3.6V DC (1 AA-cell)	None	Radio OMS 868,95 with 2 pulse inputs	kWh	014U0236
		Return	5-95°C	PVC 1.5m	Battery 3.6V DC (1 AA-cell)	None	Radio OMS WB 868,95 with 2 pulse inputs	kWh	014U0250
		Return	5-95°C	PVC 1.5m	Battery 3.6V DC (1 AA-cell)	Wired M-Bus	No module	kWh	014U0003
		Supply	5-95°C	PVC 1.5m	Battery 3.6V DC (1 AA-cell)	Wired M-Bus	No module	kWh	014U0004
		Supply	5-95°C	PVC 1.5m	Battery 3.6V DC (1 AA-cell)	Wired M-Bus	No module	GJ	014U0028
		Return	5-95°C	PVC 1.5m	Battery 3.6V DC (1 AA-cell)	Wired M-Bus	No module	GJ	014U0029
		Return	5-95°C	PVC 1.5m	Battery 3.6V DC (1 AA-cell)	Wired M-Bus	2 pulse inputs	kWh	014U0203
Supply	5-95°C	PVC 1.5m	Battery 3.6V DC (1 AA-cell)	Wired M-Bus	2 pulse inputs	kWh	014U0204		
Return	5-95°C	PVC 1.5m	Mains power 230V	Wired M-Bus	No module	kWh	014U0361		
Supply	5-95°C	PVC 1.5m	Mains power 230V	Wired M-Bus	No module	kWh	014U0362		
DN15 qp1.5m ³ /h G ³ / ₄ 110mm	PN16	Return	5-95°C	PVC 1.5m	Battery 3.6V DC (1 AA-cell)	None	No module	kWh	014U0005
		Supply	5-95°C	PVC 1.5m	Battery 3.6V DC (1 AA-cell)	None	No module	kWh	014U0006
		Supply	5-95°C	PVC 1.5m	Battery 3.6V DC (1 AA-cell)	None	No module	GJ	014U0033
		Return	5-95°C	PVC 1.5m	Battery 3.6V DC (1 AA-cell)	None	No module	GJ	014U0034
		Return	5-95°C	PVC 1.5m	Battery 3.6V DC (1 AA-cell)	None	Radio OMS 868,95 with 2 pulse inputs	kWh	014U0237
		Supply	5-95°C	PVC 1.5m	Battery 3.6V DC (1 AA-cell)	None	Radio OMS 868,95 with 2 pulse inputs	kWh	014U0238
		Return	5-95°C	PVC 1.5m	Battery 3.6V DC (1 AA-cell)	None	Radio OMS WB 868,95 with 2 pulse inputs	kWh	014U0251
		Return	5-95°C	PVC 1.5m	Battery 3.6V DC (1 AA-cell)	Wired M-Bus	No module	kWh	014U0007
		Supply	5-95°C	PVC 1.5m	Battery 3.6V DC (1 AA-cell)	Wired M-Bus	No module	kWh	014U0008
		Supply	5-95°C	PVC 1.5m	Battery 3.6V DC (1 AA-cell)	Wired M-Bus	No module	GJ	014U0035
		Return	5-95°C	PVC 1.5m	Battery 3.6V DC (1 AA-cell)	Wired M-Bus	No module	GJ	014U0036
		Return	5-95°C	PVC 1.5m	Battery 3.6V DC (1 AA-cell)	Wired M-Bus	2 pulse inputs	kWh	014U0205
		Supply	5-95°C	PVC 1.5m	Battery 3.6V DC (1 AA-cell)	Wired M-Bus	2 pulse inputs	kWh	014U0206
		Return	5-95°C	PVC 1.5m	Mains power 230V	Wired M-Bus	No module	kWh	014U0363
Supply	5-95°C	PVC 1.5m	Mains power 230V	Wired M-Bus	No module	kWh	014U0364		
DN20 qp1.5m ³ /h G1 130mm	PN16	Return	5-95°C	PVC 1.5m	Battery 3.6V DC (1 AA-cell)	None	No module	kWh	014U0009
		Supply	5-95°C	PVC 1.5m	Battery 3.6V DC (1 AA-cell)	None	No module	kWh	014U0010
		Supply	5-95°C	PVC 1.5m	Battery 3.6V DC (1 AA-cell)	None	No module	GJ	014U0040
		Return	5-95°C	PVC 1.5m	Battery 3.6V DC (1 AA-cell)	None	No module	GJ	014U0041
		Return	5-95°C	PVC 1.5m	Battery 3.6V DC (1 AA-cell)	None	Radio OMS 868,95 with 2 pulse inputs	kWh	014U0239
		Supply	5-95°C	PVC 1.5m	Battery 3.6V DC (1 AA-cell)	None	Radio OMS 868,95 with 2 pulse inputs	kWh	014U0240
		Return	5-95°C	PVC 1.5m	Battery 3.6V DC (1 AA-cell)	Wired M-Bus	No module	kWh	014U0011
		Supply	5-95°C	PVC 1.5m	Battery 3.6V DC (1 AA-cell)	Wired M-Bus	No module	kWh	014U0012
		Supply	5-95°C	PVC 1.5m	Battery 3.6V DC (1 AA-cell)	Wired M-Bus	No module	GJ	014U0042
		Return	5-95°C	PVC 1.5m	Battery 3.6V DC (1 AA-cell)	Wired M-Bus	No module	GJ	014U0043
		Return	5-95°C	PVC 1.5m	Battery 3.6V DC (1 AA-cell)	Wired M-Bus	2 pulse inputs	kWh	014U0207
		Supply	5-95°C	PVC 1.5m	Battery 3.6V DC (1 AA-cell)	Wired M-Bus	2 pulse inputs	kWh	014U0208
		Return	5-95°C	PVC 1.5m	Mains power 230V	Wired M-Bus	No module	kWh	014U0365
		Supply	5-95°C	PVC 1.5m	Mains power 230V	Wired M-Bus	No module	kWh	014U0366
DN20 qp2.5m ³ /h G1 130mm	PN16	Return	5-95°C	PVC 1.5m	Battery 3.6V DC (1 AA-cell)	None	No module	kWh	014U0013
		Supply	5-95°C	PVC 1.5m	Battery 3.6V DC (1 AA-cell)	None	No module	kWh	014U0014
		Supply	5-95°C	PVC 1.5m	Battery 3.6V DC (1 AA-cell)	None	No module	GJ	014U0047
		Return	5-95°C	PVC 1.5m	Battery 3.6V DC (1 AA-cell)	None	No module	GJ	014U0048
		Return	5-95°C	PVC 1.5m	Battery 3.6V DC (1 AA-cell)	None	Radio OMS 868,95 with 2 pulse inputs	kWh	014U0241
		Supply	5-95°C	PVC 1.5m	Battery 3.6V DC (1 AA-cell)	None	Radio OMS 868,95 with 2 pulse inputs	kWh	014U0242
		Return	5-95°C	PVC 1.5m	Battery 3.6V DC (1 AA-cell)	None	Radio OMS WB 868,95 with 2 pulse inputs	kWh	014U0252

Ordering
SonoSafe 10 - Heating (continuous)

Meter size	PN	Installation	Temperature Range [°C]	Cable length temperature sensor	Power supply	Integrated communication	Modules	Energy unit	Code No.
DN20 qp2.5m ³ /h G1 130mm	PN16	Return	5-95°C	PVC 1.5m	Battery 3.6V DC (1 AA-cell)	Wired M-Bus	No module	kWh	014U0015
		Supply	5-95°C	PVC 1.5m	Battery 3.6V DC (1 AA-cell)	Wired M-Bus	No module	kWh	014U0016
		Supply	5-95°C	PVC 1.5m	Battery 3.6V DC (1 AA-cell)	Wired M-Bus	No module	GJ	014U0049
		Return	5-95°C	PVC 1.5m	Battery 3.6V DC (1 AA-cell)	Wired M-Bus	No module	GJ	014U0050
		Return	5-95°C	PVC 1.5m	Battery 3.6V DC (1 AA-cell)	Wired M-Bus	2 pulse inputs	kWh	014U0209
		Supply	5-95°C	PVC 1.5m	Battery 3.6V DC (1 AA-cell)	Wired M-Bus	2 pulse inputs	kWh	014U0210
		Return	5-95°C	PVC 1.5m	Mains power 230V	Wired M-Bus	No module	kWh	014U0367
		Supply	5-95°C	PVC 1.5m	Mains power 230V	Wired M-Bus	No module	kWh	014U0368
DN25 qp3.5m ³ /h G1¼ 160mm	PN16	Return	5-95°C	PVC 1.5m	Battery 3.6V DC (1 AA-cell)	None	No module	kWh	014U0017
		Supply	5-95°C	PVC 1.5m	Battery 3.6V DC (1 AA-cell)	None	No module	kWh	014U0018
		Supply	5-95°C	PVC 1.5m	Battery 3.6V DC (1 AA-cell)	None	No module	GJ	014U0054
		Return	5-95°C	PVC 1.5m	Battery 3.6V DC (1 AA-cell)	None	No module	GJ	014U0055
		Return	5-95°C	PVC 1.5m	Battery 3.6V DC (1 AA-cell)	None	Radio OMS 868,95 with 2 pulse inputs	kWh	014U0243
		Supply	5-95°C	PVC 1.5m	Battery 3.6V DC (1 AA-cell)	None	Radio OMS 868,95 with 2 pulse inputs	kWh	014U0244
		Return	5-95°C	PVC 1.5m	Battery 3.6V DC (1 AA-cell)	None	Radio OMS WB 868,95 with 2 pulse inputs	kWh	014U0332
		Return	5-95°C	PVC 1.5m	Battery 3.6V DC (1 AA-cell)	Wired M-Bus	No module	kWh	014U0019
		Supply	5-95°C	PVC 1.5m	Battery 3.6V DC (1 AA-cell)	Wired M-Bus	No module	kWh	014U0020
		Supply	5-95°C	PVC 1.5m	Battery 3.6V DC (1 AA-cell)	Wired M-Bus	No module	GJ	014U0056
		Return	5-95°C	PVC 1.5m	Battery 3.6V DC (1 AA-cell)	Wired M-Bus	No module	GJ	014U0057
		Return	5-95°C	PVC 1.5m	Battery 3.6V DC (1 AA-cell)	Wired M-Bus	2 pulse inputs	kWh	014U0211
Supply	5-95°C	PVC 1.5m	Battery 3.6V DC (1 AA-cell)	Wired M-Bus	2 pulse inputs	kWh	014U0212		
DN25 qp3.5m ³ /h G1¼ 260mm	PN16	Return	5-95°C	PVC 1.5m	Battery 3.6V DC (1 AA-cell)	None	No module	kWh	014U0021
		Supply	5-95°C	PVC 1.5m	Battery 3.6V DC (1 AA-cell)	None	No module	kWh	014U0022
		Supply	5-95°C	PVC 1.5m	Battery 3.6V DC (1 AA-cell)	None	No module	GJ	014U0061
		Return	5-95°C	PVC 1.5m	Battery 3.6V DC (1 AA-cell)	None	No module	GJ	014U0062
		Return	5-95°C	PVC 1.5m	Battery 3.6V DC (1 AA-cell)	None	Radio OMS 868,95 with 2 pulse inputs	kWh	014U0245
		Supply	5-95°C	PVC 1.5m	Battery 3.6V DC (1 AA-cell)	None	Radio OMS 868,95 with 2 pulse inputs	kWh	014U0246
		Return	5-95°C	PVC 1.5m	Battery 3.6V DC (1 AA-cell)	Wired M-Bus	No module	kWh	014U0023
		Supply	5-95°C	PVC 1.5m	Battery 3.6V DC (1 AA-cell)	Wired M-Bus	No module	kWh	014U0024
		Supply	5-95°C	PVC 1.5m	Battery 3.6V DC (1 AA-cell)	Wired M-Bus	No module	GJ	014U0063
		Return	5-95°C	PVC 1.5m	Battery 3.6V DC (1 AA-cell)	Wired M-Bus	No module	GJ	014U0064
		Return	5-95°C	PVC 1.5m	Mains power 230V	Wired M-Bus	No module	kWh	014U0369
		Supply	5-95°C	PVC 1.5m	Mains power 230V	Wired M-Bus	No module	kWh	014U0370
DN25 qp6.0m ³ /h G1¼ 260mm	PN16	Return	5-95°C	PVC 1.5m	Battery 3.6V DC (1 AA-cell)	None	No module	kWh	014U0264
		Supply	5-95°C	PVC 1.5m	Battery 3.6V DC (1 AA-cell)	None	No module	kWh	014U0265
		Return	5-95°C	PVC 1.5m	Battery 3.6V DC (1 AA-cell)	None	Radio OMS WB 868,95 with 2 pulse inputs	kWh	014U0333
		Return	5-95°C	PVC 1.5m	Battery 3.6V DC (1 AA-cell)	Wired M-Bus	No module	kWh	014U0266
		Supply	5-95°C	PVC 1.5m	Battery 3.6V DC (1 AA-cell)	Wired M-Bus	No module	kWh	014U0267
		Return	5-95°C	PVC 1.5m	Mains power 230V	Wired M-Bus	No module	kWh	014U0371
		Supply	5-95°C	PVC 1.5m	Mains power 230V	Wired M-Bus	No module	kWh	014U0372
DN32 qp6.0m ³ /h G1½ 260mm	PN16	Return	5-95°C	PVC 1.5m	Battery 3.6V DC (1 AA-cell)	None	No module	kWh	014U0274
		Supply	5-95°C	PVC 1.5m	Battery 3.6V DC (1 AA-cell)	None	No module	kWh	014U0275
		Return	5-95°C	PVC 1.5m	Battery 3.6V DC (1 AA-cell)	None	Radio OMS WB 868,95 with 2 pulse inputs	kWh	014U0334
		Return	5-95°C	PVC 1.5m	Battery 3.6V DC (1 AA-cell)	Wired M-Bus	No module	kWh	014U0276
		Supply	5-95°C	PVC 1.5m	Battery 3.6V DC (1 AA-cell)	Wired M-Bus	No module	kWh	014U0277

Ordering
SonoSelect 10 - Cooling

Meter size	PN	Installation	Temperature Range [°C]	Cable length temperature sensor	Power supply	Integrated communication	Modules	Energy unit	Code No.
DN15 qp0.6m ³ /h G ³ / ₄ 110mm	PN25	Return	5-95°C	PUR 1.5m	Battery 3.6V DC (2 AA-cell)	Wired M-Bus	No module	kWh	014U1400
		Return	5-95°C	PUR 1.5m	Battery 3.6V DC (2 AA-cell)	Wired M-Bus	2 pulse inputs	kWh	014U1405
		Return	5-95°C	PUR 1.5m	Battery 3.6V DC (2 AA-cell)	None	Radio OMS 868,95 with 2 pulse inputs	kWh	014U1410
		Return	5-95°C	PUR 1.5m	Battery 3.6V DC (2 AA-cell)	None	Radio OMS WB 868,95 with 2 pulse inputs	kWh	014U1448
		Return	5-95°C	PUR 1.5m	Mains power 230V	Wired M-Bus	No module	kWh	014U1456
		Return	5-95°C	PUR 1.5m	Mains power 230V	None	Radio OMS 868,95 with 2 pulse inputs	kWh	014U1463
DN15 qp1.5m ³ /h G ³ / ₄ 110mm	PN25	Return	5-95°C	PUR 1.5m	Battery 3.6V DC (2 AA-cell)	Wired M-Bus	No module	kWh	014U1401
		Return	5-95°C	PUR 1.5m	Battery 3.6V DC (2 AA-cell)	Wired M-Bus	2 pulse inputs	kWh	014U1406
		Return	5-95°C	PUR 1.5m	Battery 3.6V DC (2 AA-cell)	None	Radio OMS 868,95 with 2 pulse inputs	kWh	014U1411
		Return	5-95°C	PUR 1.5m	Battery 3.6V DC (2 AA-cell)	Wired M-Bus	Wired M-Bus with 2 pulse inputs	kWh	014U1415
		Return	5-95°C	PUR 3.0m	Battery 3.6V DC (2 AA-cell)	None	Radio OMS WB 868,95 with 2 pulse inputs	kWh	014U1435
		Return	5-95°C	PUR 1.5m	Battery 3.6V DC (2 AA-cell)	None	Radio OMS WB 868,95 with 2 pulse inputs	kWh	014U1449
		Return	5-95°C	PUR 3.0m	Battery 3.6V DC (2 AA-cell)	Wired M-Bus	Wired M-Bus with 2 pulse inputs	kWh	014U1455
		Return	5-95°C	PUR 1.5m	Mains power 230V	Wired M-Bus	No module	kWh	014U1457
		Return	5-95°C	PUR 1.5m	Mains power 230V	None	Radio OMS 868,95 with 2 pulse inputs	kWh	014U1464
		Return	5-95°C	PUR 1.5m	Mains power 230V	Wired M-Bus	Wired M-Bus with 2 pulse inputs	kWh	014U1470
DN20 qp1.5m ³ /h G1 130mm	PN25	Return	5-95°C	PUR 1.5m	Battery 3.6V DC (2 AA-cell)	Wired M-Bus	No module	kWh	014U1402
		Return	5-95°C	PUR 1.5m	Battery 3.6V DC (2 AA-cell)	Wired M-Bus	2 pulse inputs	kWh	014U1407
		Return	5-95°C	PUR 1.5m	Battery 3.6V DC (2 AA-cell)	None	Radio OMS 868,95 with 2 pulse inputs	kWh	014U1412
		Return	5-95°C	PUR 1.5m	Battery 3.6V DC (2 AA-cell)	Wired M-Bus	Wired M-Bus with 2 pulse inputs	kWh	014U1416
		Return	5-95°C	PUR 1.5m	Battery 3.6V DC (2 AA-cell)	None	Radio OMS WB 868,95 with 2 pulse inputs	kWh	014U1450
		Return	5-95°C	PUR 1.5m	Mains power 230V	Wired M-Bus	No module	kWh	014U1458
		Return	5-95°C	PUR 1.5m	Mains power 230V	None	Radio OMS 868,95 with 2 pulse inputs	kWh	014U1465
		Return	5-95°C	PUR 1.5m	Mains power 230V	Wired M-Bus	Wired M-Bus with 2 pulse inputs	kWh	014U1471
DN20 qp2.5m ³ /h G1 130mm	PN25	Return	5-95°C	PUR 1.5m	Battery 3.6V DC (2 AA-cell)	Wired M-Bus	No module	kWh	014U1403
		Return	5-95°C	PUR 1.5m	Battery 3.6V DC (2 AA-cell)	Wired M-Bus	2 pulse inputs	kWh	014U1408
		Return	5-95°C	PUR 1.5m	Battery 3.6V DC (2 AA-cell)	None	Radio OMS 868,95 with 2 pulse inputs	kWh	014U1413
		Return	5-95°C	PUR 1.5m	Battery 3.6V DC (2 AA-cell)	Wired M-Bus	Wired M-Bus with 2 pulse inputs	kWh	014U1417
		Return	5-95°C	PUR 3.0m	Battery 3.6V DC (2 AA-cell)	None	Radio OMS WB 868,95 with 2 pulse inputs	kWh	014U1436
		Return	5-95°C	PUR 1.5m	Battery 3.6V DC (2 AA-cell)	None	Radio OMS WB 868,95 with 2 pulse inputs	kWh	014U1451
		Return	5-95°C	PUR 5.0m	Battery 3.6V DC (2 AA-cell)	Wired M-Bus	Wired M-Bus with 2 pulse inputs	kWh	014U1473
		Return	5-95°C	PUR 1.5m	Mains power 230V	Wired M-Bus	No module	kWh	014U1459
		Return	5-95°C	PUR 1.5m	Mains power 230V	None	Radio OMS 868,95 with 2 pulse inputs	kWh	014U1466
		Return	5-95°C	PUR 1.5m	Mains power 230V	Wired M-Bus	Wired M-Bus with 2 pulse inputs	kWh	014U1472
DN25 qp3.5m ³ /h G1 ¹ / ₄ 160mm	PN25	Return	5-95°C	PUR 1.5m	Battery 3.6V DC (2 AA-cell)	Wired M-Bus	No module	kWh	014U1404
		Return	5-95°C	PUR 1.5m	Battery 3.6V DC (2 AA-cell)	Wired M-Bus	2 pulse inputs	kWh	014U1409
		Return	5-95°C	PUR 1.5m	Battery 3.6V DC (2 AA-cell)	None	Radio OMS 868,95 with 2 pulse inputs	kWh	014U1414
		Return	5-95°C	PUR 1.5m	Battery 3.6V DC (2 AA-cell)	None	Radio OMS WB 868,95 with 2 pulse inputs	kWh	014U1452
		Return	5-95°C	PUR 3.0m	Battery 3.6V DC (2 AA-cell)	None	Radio OMS WB 868,95 with 2 pulse inputs	kWh	014U1453
		Return	5-95°C	PUR 5.0m	Battery 3.6V DC (2 AA-cell)	Wired M-Bus	Wired M-Bus with 2 pulse inputs	kWh	014U1474

Ordering

SonoSelect 10 - Cooling (continuous)

Meter size	PN	Installation	Temperature Range [°C]	Cable length temperature sensor	Power supply	Integrated communication	Modules	Energy unit	Code No.
DN25 qp3.5m ³ /h G1¼ 160mm	PN25	Return	5-95°C	PUR 1.5m	Mains power 230V	Wired M-Bus	No module	kWh	014U1460
		Return	5-95°C	PUR 1.5m	Mains power 230V	None	Radio OMS 868,95 with 2 pulse inputs	kWh	014U1467
DN25 qp3.5m ³ /h G1¼ 260mm	PN25	Return	5-95°C	PUR 1.5m	Battery 3.6V DC (2 AA-cell)	Wired M-Bus	No module	kWh	014U1424
		Return	5-95°C	PUR 1.5m	Battery 3.6V DC (2 AA-cell)	Wired M-Bus	2 pulse inputs	kWh	014U1425
		Return	5-95°C	PUR 1.5m	Battery 3.6V DC (2 AA-cell)	None	Radio OMS 868,95 with 2 pulse inputs	kWh	014U1426
DN25 qp6.0m ³ /h G1¼ 260mm	PN25	Return	5-95°C	PUR 1.5m	Battery 3.6V DC (2 AA-cell)	Wired M-Bus	No module	kWh	014U1429
		Return	5-95°C	PUR 1.5m	Battery 3.6V DC (2 AA-cell)	Wired M-Bus	2 pulse inputs	kWh	014U1430
		Return	5-95°C	PUR 1.5m	Battery 3.6V DC (2 AA-cell)	None	Radio OMS 868,95 with 2 pulse inputs	kWh	014U1431
		Return	5-95°C	PUR 3.0m	Battery 3.6V DC (2 AA-cell)	None	Radio OMS WB 868,95 with 2 pulse inputs	kWh	014U1437
		Return	5-95°C	PUR 1.5m	Mains power 230V	Wired M-Bus	No module	kWh	014U1461
		Return	5-95°C	PUR 1.5m	Mains power 230V	None	Radio OMS 868,95 with 2 pulse inputs	kWh	014U1468
DN32 qp6.0m ³ /h G1½ 260mm	PN25	Return	5-95°C	PUR 1.5m	Battery 3.6V DC (2 AA-cell)	Wired M-Bus	No module	kWh	014U1432
		Return	5-95°C	PUR 1.5m	Battery 3.6V DC (2 AA-cell)	Wired M-Bus	2 pulse inputs	kWh	014U1433
		Return	5-95°C	PUR 1.5m	Battery 3.6V DC (2 AA-cell)	None	Radio OMS 868,95 with 2 pulse inputs	kWh	014U1434
		Return	5-95°C	PUR 3.0m	Battery 3.6V DC (2 AA-cell)	None	Radio OMS WB 868,95 with 2 pulse inputs	kWh	014U1454
		Return	5-95°C	PUR 5.0m	Battery 3.6V DC (2 AA-cell)	Wired M-Bus	Wired M-Bus with 2 pulse inputs	kWh	014U1475
		Return	5-95°C	PUR 1.5m	Mains power 230V	Wired M-Bus	No module	kWh	014U1462
		Return	5-95°C	PUR 1.5m	Mains power 230V	None	Radio OMS 868,95 with 2 pulse inputs	kWh	014U1469

Ordering

SonoSelect 10 - Combined Heating and Cooling

Meter size	PN	Installation	Temperature Range [°C]	Cable length temperature sensor	Power supply	Integrated communication	Modules	Energy unit	Code No.
DN15 qp0.6m ³ /h G¾ 110mm	PN16	Return	5-95°C	PUR 1.5m	Battery 3.6V DC (2 AA-cell)	Wired M-Bus	No module	kWh	014U1300
		Return	5-95°C	PUR 1.5m	Battery 3.6V DC (2 AA-cell)	None	Radio OMS WB 868,95 with 2 pulse inputs	kWh	014U1307
		Return	5-95°C	PUR 1.5m	Battery 3.6V DC (2 AA-cell)	Wired M-Bus	2 pulse inputs	kWh	014U1314
		Return	5-95°C	PUR 1.5m	Mains power 230V	Wired M-Bus	No module	kWh	014U1334
DN15 qp1.5m ³ /h G¾ 110mm	PN16	Return	5-95°C	PUR 1.5m	Battery 3.6V DC (2 AA-cell)	Wired M-Bus	No module	kWh	014U1301
		Return	5-95°C	PUR 1.5m	Battery 3.6V DC (2 AA-cell)	None	Radio OMS WB 868,95 with 2 pulse inputs	kWh	014U1308
		Return	5-95°C	PUR 1.5m	Battery 3.6V DC (2 AA-cell)	Wired M-Bus	2 pulse inputs	kWh	014U1315
DN20 qp1.5m ³ /h G1 130mm	PN16	Return	5-95°C	PUR 1.5m	Mains power 230V	Wired M-Bus	No module	kWh	014U1335
		Return	5-95°C	PUR 1.5m	Battery 3.6V DC (2 AA-cell)	Wired M-Bus	No module	kWh	014U1302
		Return	5-95°C	PUR 1.5m	Battery 3.6V DC (2 AA-cell)	None	Radio OMS WB 868,95 with 2 pulse inputs	kWh	014U1309
DN20 qp2.5m ³ /h G1 130mm	PN16	Return	5-95°C	PUR 1.5m	Battery 3.6V DC (2 AA-cell)	Wired M-Bus	2 pulse inputs	kWh	014U1316
		Return	5-95°C	PUR 1.5m	Mains power 230V	Wired M-Bus	No module	kWh	014U1336
		Return	5-95°C	PUR 1.5m	Battery 3.6V DC (2 AA-cell)	Wired M-Bus	No module	kWh	014U1303
DN20 qp3.5m ³ /h G1 130mm	PN16	Return	5-95°C	PUR 1.5m	Battery 3.6V DC (2 AA-cell)	None	Radio OMS WB 868,95 with 2 pulse inputs	kWh	014U1310
		Return	5-95°C	PUR 1.5m	Battery 3.6V DC (2 AA-cell)	Wired M-Bus	2 pulse inputs	kWh	014U1317
		Return	5-95°C	PUR 1.5m	Mains power 230V	Wired M-Bus	No module	kWh	014U1337
DN25 qp3.5m ³ /h G1¼ 160mm	PN16	Return	5-95°C	PUR 1.5m	Battery 3.6V DC (2 AA-cell)	Wired M-Bus	No module	kWh	014U1304
		Return	5-95°C	PUR 1.5m	Battery 3.6V DC (2 AA-cell)	None	Radio OMS WB 868,95 with 2 pulse inputs	kWh	014U1311
		Return	5-95°C	PUR 1.5m	Battery 3.6V DC (2 AA-cell)	Wired M-Bus	2 pulse inputs	kWh	014U1318
DN25 qp6.0m ³ /h G1¼ 260mm	PN16	Return	5-95°C	PUR 1.5m	Mains power 230V	Wired M-Bus	No module	kWh	014U1338
		Return	5-95°C	PUR 1.5m	Battery 3.6V DC (2 AA-cell)	Wired M-Bus	2 pulse inputs	kWh	014U1319
DN25 qp6.0m ³ /h G1¼ 260mm	PN16	Return	5-95°C	PUR 1.5m	Battery 3.6V DC (2 AA-cell)	Wired M-Bus	No module	kWh	014U1305
		Return	5-95°C	PUR 1.5m	Battery 3.6V DC (2 AA-cell)	None	Radio OMS WB 868,95 with 2 pulse inputs	kWh	014U1312

Data sheet

SonoSelect 10 and SonoSafe 10 energy meters

Ordering SonoSelect 10 - Combined Heating and Cooling (continuous)

Meter size	PN	Installation	Temperature Range [Ø]	Cable length temperature sensor	Power supply	Integrated communication	Modules	Energy unit	Code No.
DN25 qp6.0m³/h G1¼ 260mm	PN16	Return	5-95°C	PUR 1.5m	Battery 3.6V DC (2 AA-cell)	Wired M-Bus	2 pulse inputs	kWh	014U1320
		Return	5-95°C	PUR 1.5m	Mains power 230V	Wired M-Bus	No module	kWh	014U1339
DN32 qp6.0m³/h G1½ 260mm	PN16	Return	5-95°C	PUR 1.5m	Battery 3.6V DC (2 AA-cell)	Wired M-Bus	No module	kWh	014U1306
		Return	5-95°C	PUR 1.5m	Battery 3.6V DC (2 AA-cell)	None	Radio OMS WB 868,95 with 2 pulse inputs	kWh	014U1313
		Return	5-95°C	PUR 1.5m	Battery 3.6V DC (2 AA-cell)	Wired M-Bus	2 pulse inputs	kWh	014U1321
		Return	5-95°C	PUR 1.5m	Mains power 230V	Wired M-Bus	No module	kWh	014U1340

Accessories

Product	Designation	Quantity	Code No.
Tailpiece connection set	DN15 G3/4"-R1/2" PN25 130 °C	1 set	087G6071
Tailpiece connection set	DN20 G1"-R3/4" PN25 130 °C	1 set	087G6072
Tailpiece connection set	DN25 G1 1/4"-R1" PN25 130 °C	1 set	087G6073
Tailpiece connection set	DN15 G3/4"-R1/2" PN16 95 °C	1 set	014U1936
Tailpiece connection set	DN20 G1"-R3/4" PN16 95 °C	1 set	014U1937
Tailpiece connection set	DN25 G1 1/4"-R1" PN16 95 °C	1 set	014U1938
Tailpiece connection set	DN32: G1 1/2"-R5/4" PN25 130 °C	1 set	014U1939
Adapter for temperature sensor	Adapter R½" to M10x1 (32pcs.) - conical thread for sealing with hemp. PN25 130 °C	32 pcs	014U1935
Adapter for temperature sensor	Adapter R½" to M10x1 (1pc) - conical thread for sealing with hemp. PN25 130 °C	1 pc	014U1941
Adapter for temperature sensor	Adapter R½" to M10x1 (32pcs.) - incl. copper gasket for flat sealing. PN25 130 °C	32 pcs	087G6076
Adapter for temperature sensor	Adapter R½" to M10x1 (1pc) - incl. copper gasket for flat sealing. PN25 130 °C	1 pc	087G6075
Tee fitting	T-fitting DN15: G½", G½", G½" PN25 130 °C	1 pc	014U1959
Tee fitting	T-fitting DN20: G¾", G½", G¾" PN25 130 °C	1 pc	014U1960
Tee fitting	T-fitting DN25: G1", G½", G1" PN25 130 °C	1 pc	014U1961
Tee fitting	T-Fitting DN32: G1 1/4", G½", G1 1/4" PN25 130 °C	1 pc	014U1943
Ball valve	G½" internal thread, Pt sensor connection M10, PN25 130 °C	1 pc.	187F0593
Ball valve	G½" internal thread, Pt sensor connection M10, PN25 130 °C	12 pcs.	087H0118
Ball valve	G¾" internal thread, Pt sensor connection M10, PN25 130 °C	1 pc.	187F0592
Ball valve	G¾" internal thread, Pt sensor connection M10, PN25 130 °C	12 pcs.	087H0119
Ball valve	G1" internal thread, Pt sensor connection M10, PN25 130 °C	1 pc.	187F0591
Ball valve	G1" internal thread, Pt sensor connection M10, PN25 130 °C	12 pcs.	087H0120
Wall mounting kit	Calculator wall mounting	1 set	014U1945
Cable	M-Bus 2 wire cable (22 AWG), 1 m PVC, ferrules	1 pc.	014U1946
Cable	M-Bus 2 wire cable (22 AWG), 2.5 m PVC, ferrules	1 pc.	014U1947
Cable	M-Bus 2 wire cable (22 AWG), 5 m PVC, ferrules	1 pc.	014U1948
Cable	M-Bus 2 wire cable (22 AWG), 9.75 m PVC, ferrules	1 pc.	014U1949
Cable	Pulse input/output 2 wire cable. (22 AWG), 2.5 m PVC, ferrules	1 pc.	014U1950
Cable	Pulse input/output 2 wire cable. (22 AWG), 5 m PVC, ferrules	1 pc.	014U1951
Cable	Pulse input/output 2 wire cable. (22 AWG), 9.75 m PVC, ferrules	1 pc.	014U1952
Extension pipe, L = 60 mm	DN20 x G1	1 pc.	014U1957
Extension pipe, L = 100 mm	DN25 x G1¼	1 pc.	014U1958
Gasket	DN15	1 set	014U1964
Gasket	DN20	1 set	014U1965
Gasket	DN25	1 set	014U1966
Gasket	DN32	1 set	014U1942
O-ring mounting kit	O-ring Ø4.3 x 2.4 + assembly tool	1 set	014U1967
Battery	Battery pack 1 AA cell	1 pc.	014U1968
Battery	Battery pack 2 AA cell	1 pc.	014U1969
Communication module	M-Bus module with 2 pulse inputs	1 pc.	014U1998
Communication module	Wireless OMS 868.95MHz with 2 pulse inputs	1 pc.	014U1999
Communication module	2 pulse inputs	1 pc.	014U1995
Bluetooth dongle	IR2BLE	1 pc.	014U1963
Sealing kit	4 x wire with + 4 x snap lock seal	1 set	014U1962

* On request new codes with unique specification combination can be created. If needed please contact you local product manager.

Danfoss A/S

Heating Segment • danfoss.com • +45 7488 2222 • E-Mail: heating@danfoss.com

Danfoss can accept no responsibility for possible errors in catalogues, brochures and other printed material. Danfoss reserves the right to alter its products without notice. This also applies to products already on order provided that such alterations can be made without subsequent changes being necessary in specifications already agreed. All trademarks in this material are property of the respective companies. Danfoss and all Danfoss logotypes are trademarks of Danfoss A/S. All rights reserved.